

An Efficient Low-Profile Microstrip Antenna for Aqueous Glucose Measurement

Ashwini S. Jagtap¹, S.D. Sawarkar²

¹Department of Electronics and Telecommunication, DMCE, Airoli, India

²Department of Electronics and Telecommunication, DMCE, Airoli, India

Corresponding Author: asu1791992@gmail.com

Received 17th Mar 2017, Revised 04th Apr 2017, Accepted 26th May 2017, Online 30th Jun 2017

Abstract- Millions of people are suffering from Diabetes worldwide. According to the World Health Organization (WHO), number of diabetes patients is likely to rise to 101 million in India by 2030 and will become the world's 7th largest killer. Hence we have to utilize technology to eradicate this disease. Measuring glucose level in a diabetic patient on a regular basis and administering insulin are the keys to keep patient safe and device which measures blood glucose level is called Glucometer. Presently glucose can be measured using two techniques, invasive and non-invasive, also known as in-vivo and in-vitro respectively. microwave resonator antenna is used in this project for non-invasive technique as a new approach towards blood glucose measurement. In this work, low profile microstrip antennas for glucometer application are proposed. As the dielectric constant of the material used as a substrate placed above antenna changes, resonant characteristic of antenna varies and shift in the frequency is observed. The proposed microstrip antenna resonators are designed using Advanced Design System 2011.05 for an operating frequency as low as 1 GHz. The operating frequency of antenna should be low as the low frequency microwave signal penetrate deep into tissues and have potential for practical application because of low physical area, low cost and better frequency resolution. Further, a high frequency resolution i.e. for a small change in glucose concentration leads to considerable shift in operating frequency, is achieved. The proposed Microstrip antennas are designed and tested with aqueous glucose substrate. This is advancement towards developing microstrip sensor for non-invasive glucometer application.

Keywords: Diabetes, Aqueous Glucose, Dielectric constant, Microwave Sensors, Microwave Resonator.

I. INTRODUCTION

Diabetes is a disease that afflicts millions worldwide. It results from the body's improper regulation of the hormone insulin. Insulin is used to break down glucose, a biological sugar that is the body's power source. To be healthy, the body must maintain glucose concentration within a specific range; if the concentration falls out of this range, then permanent damage to vital organs may result. Hence it is important for diabetics to monitor their glucose levels. Over the past half-century, microwave instruments have been used increasingly in a wide range of sensing applications. Their ability to non-destructively measure parameters inside a volume makes them ideal for measuring in harsh or sensitive environments where direct contact to the sample cannot be achieved. This property of microwave sensors suggests that they would be well suited for non-invasively measuring physiological parameters in humans. One such parameter, and the guiding example for this research, is blood glucose concentration, which diabetics must closely monitor.

A. Blood glucose measurement techniques:

Invasive technique: In invasive techniques one drop of blood is taken from finger tip of a patient and is then collected on a test strip, that strip is then inserted into glucometer and blood glucose measurement is done. This

technique is both, costly and painful; also there is a chance of infection.

Non-invasive technique: In non-invasive technique various technologies are used such as near infrared spectroscopy, Optical coherence tomography, Raman spectroscopy, Ultrasound technology, Thermal spectroscopy, Fluorescence technology, Impedance spectroscopy, etc.

B. Permittivity and Biological Modeling:

The effects of microwaves on biological tissue are dependent on the field in the tissue, or rather the power deposited in a unit mass of tissue. Permittivity of human tissues shows noticeable changes with the change in applied microwave frequency.

II. LITERATURE SURVEY

In the area of blood glucose and permittivity correlations, there has been little work done. There is minimal research, but the research that has been done suggests that a correlation exists between blood glucose and permittivity. The following studies used microwave measurement techniques other than a resonant sensor to measure the permittivity and relate it to blood glucose concentration. A non-invasive blood glucose measurement method based on ultra-wide band (UWB) microwave detecting technique is proposed for monitoring the patients' blood glucose

level. With this method, a non-invasive measurement for the blood glucose determination can be realized by analysing the received UWB microwave signals. This method is very convenient and is harmless to the patients [3].

Measurement of dielectric constant is important because it provides the electrical characteristics of the material which prove useful in research and development fields. A new technique to evaluate the dielectric constant or permittivity of the homogeneous dielectric material using a simple microstrip patch antenna has been developed in present work [4].

A new approach to non-invasive blood parameter measuring is presented, which consists of two matched antennas for transmission based two port measurements. Dielectric properties of body tissues are reviewed and their influence on transmission properties is estimated for plane wave propagation. A covered patch antenna and substrate integrated waveguide slot antenna has been designed, measured and compromised for glucose-concentration measurements [5].

Two measurement techniques for determining the complex dielectric properties of aqueous glucose solution of a variety of concentration (0 to 500 mmol/L) by using a coaxial reflectance probe (0.2 to 4 GHz) and a cylindrical cavity (3.5 GHz) is defined [6].

The author has designed ring resonator of resonance frequency 2.6 GHz and finally this ring resonator microstrip antenna was loaded with 10%, 20%, 30%, 40%, 50% aqueous glucose (% of glucose in water) [1].

III. PROBLEM STATEMENT

- To design low frequency resonator antennas such that its resonance frequency should have a maximum shift (change of more than 20 MHz for the 10% change in dielectric concentration) as the concentration of glucose changes to increase glucometer resolution. As the low microwave signal penetrates deep into tissues.
- Small size (less than 2206 sq. mm of physical area covered) of antenna as it may be used in hand held glucometer.

IV. ANTENNA ANALYSIS THEORY

- Microwave Sensors:** Sensors are devices that are ideal to measure blood since they are able to make use of lower frequencies and longer wavelengths, in order to better penetrate through the skin and fat layers of the human body. SPI does not define any maximum data rate, not any particular addressing scheme. A resonant sensor works when fringing fields interact with the dielectric that the sensor is constructed from and energy is coupled into it. This coupled energy causes a shift in the resonant frequency of the sensor where the shift is dependent on the relative permittivity of the material under test i.e. substrate. As the permittivity of the material changes a change can be seen in its S-parameters, which is either a peak or valley in the frequency response, corresponding to the sensor's

resonant frequency. Sensor configuration is based on the shift in the $|S_{11}|$ and $|S_{21}|$ parameters from a known change in the load permittivity. In this work however we will focus only on shift in frequency in $|S_{21}|$ parameter.

- Microwave Resonator:**

- Ring Resonator:** In ring resonator when signal enters into the ring from coupling gap on left side, the energy coupled into ring splits equally over the top and bottom of the ring. This will produce standing waves. A schematic representation of the standard FR4 substrate with dielectric constant 4.6 is shown in fig.1.

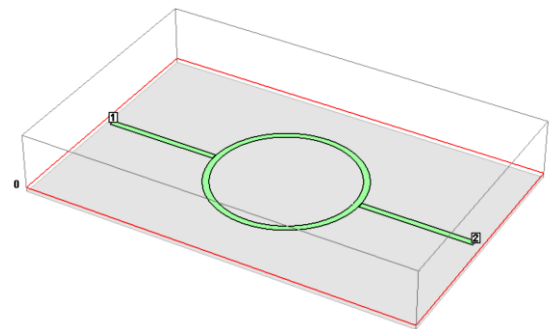

Fig.1 3D view of Microwave Ring Resonator[1].

- Single Spiral Ring Resonator:** The circular symmetry of the spiral makes it less sensitive to contact orientation than other configurations and the spiral provides a generous contact area within a small outline. A general sketch is shown in fig.2.

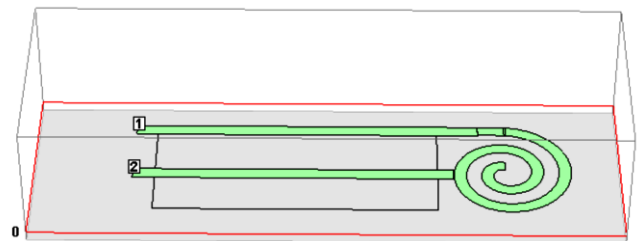

Fig.2.3D view of Single Spiral Ring Resonator [1].

- Double Spiral Ring Resonator:** The Double spiral sensor has two spirals. A general sketch of double spiral is shown in fig.3.

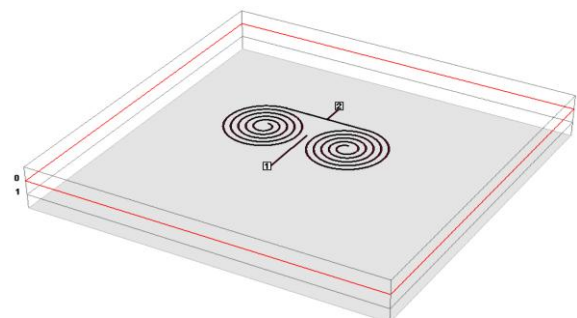

Fig.3.3D view of Double Spiral Ring Resonator [1].

V. DESIGN EQUATION

The design formulas relating the dimension and the resonant frequencies are as follows [2].

$$L_R = 2\pi r = n\lambda_g \tag{1}$$

where, L_R is the total length of resonator, r is the radius, λ_g is guided wavelength, n is the number of modes. Here $n=1$.

Assuming resonant frequency as 1 GHz using following formula for assuming length of ring resonator as [2].

$$\lambda_g = \frac{\lambda_0}{\sqrt{\epsilon_{eff}}} \tag{2}$$

Where λ_0 wavelength in air and f is resonant frequency and c is speed of light in air, given as [2]

$$\lambda_0 = \frac{c}{f} \tag{3}$$

Effective dielectric constant ϵ_{eff} is calculated by

$$\epsilon_{eff} = \frac{\epsilon_r + 1}{2} + \frac{\epsilon_r - 1}{2} \left[1 + 12 \frac{h}{W} \right]^{-2} \tag{4}$$

Dielectric constant of substrate FR4 $\epsilon_r = 4.6$ and h is height of substrate and W is width of microstrip antenna.

- Hence for Ring Resonator antenna, assuming $f=1\text{GHz}$ and $c = 3 \times 10^8 \text{ m/s}$, equation 3 gives $\lambda_0 = 300 \text{ mm}$.
- Using $\epsilon_r=4.6$ (FR4) and $h = 1.6 \text{ mm}$ and $W=1.6 \text{ mm}$, equation 4, gives $\epsilon_{eff} = 3.299$.
- Using $\epsilon_{eff}=3.299$ and $\lambda_0=300 \text{ mm}$ and, equation 2 gives $\lambda_g=165.16 \text{ mm}$. Thus, the equation 1 leads to length of total resonator $L_R=165.16 \text{ mm}$.

Implementation of Ring Resonator:

Ring resonator is implemented by using ADS 2011.05 (Aligent Advanced Design System 2011.05)

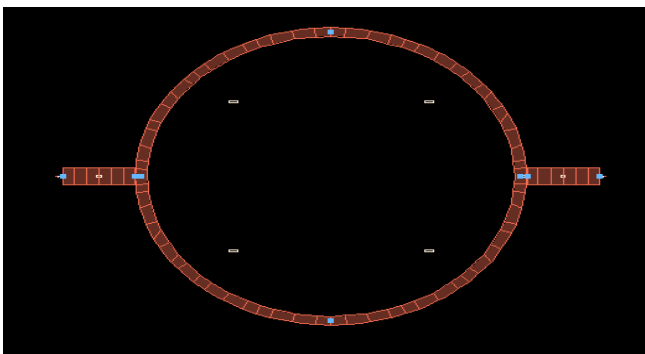

Fig.4 Layout of Ring resonator

Implementation of Single Spiral Ring Resonator:

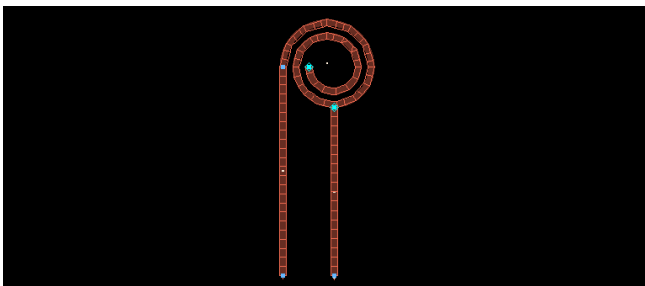

Fig.5. Layout of Single Spiral Ring resonator

Implementation of Double Spiral Ring Resonator:

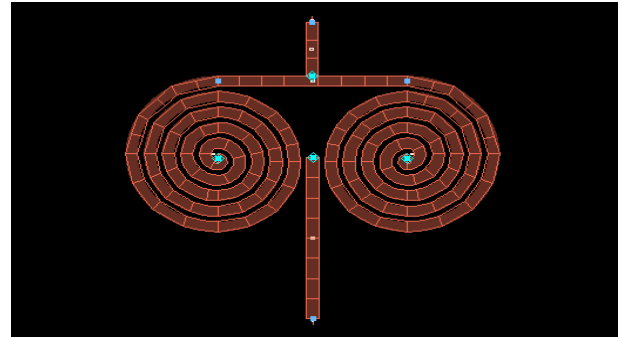

Fig.6. Layout for Double Spiral Ring resonator

VI. RESULTS

Discussion: From the simulated results of single spiral ring resonator antenna, as percentage of glucose in the water increases, maximum frequency shift in S21 (transmission coefficient) increases and its permittivity decreases. Single spiral ring resonator gives linear response, while ring resonator and double spiral ring resonator gives non-linear, uneven response. A sharp signal is created by double spiral ring resonator which can be easily interrupted, also it increases sensor size. Therefore ring resonator is selected and simulation results are obtained for varying concentrations of glucose level (0% to 50%).

• *Single Spiral Ring Resonator:*

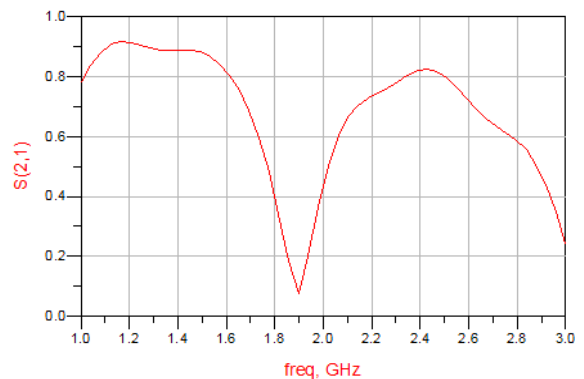

Fig.7. S- parameter |S21| for single spiral ring resonator

• *Double Spiral Ring Resonator:*

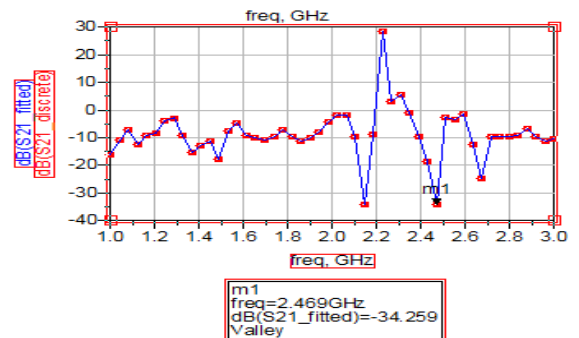

Fig.8.S-parameter |S21| for Double spiral ring resonator

• Ring Resonator:

1. For 0% glucose concentration:

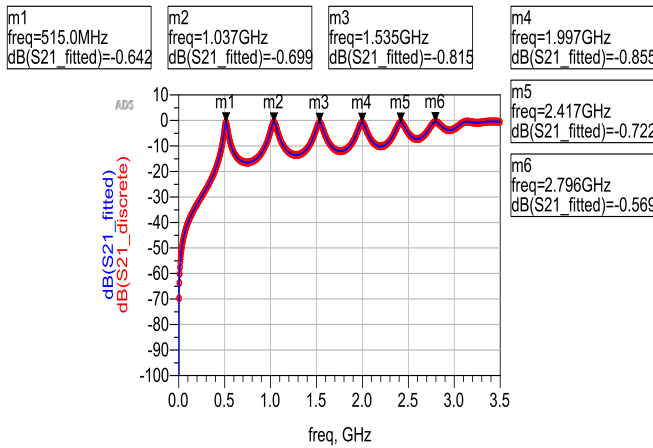

Fig.9.For 0% glucose concentration

2. For 10% glucose concentration:

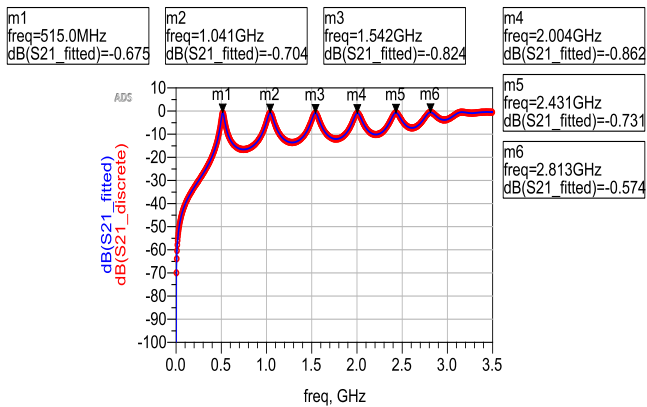

Fig.10.For 10% glucose concentration

3. For 20% glucose concentration:

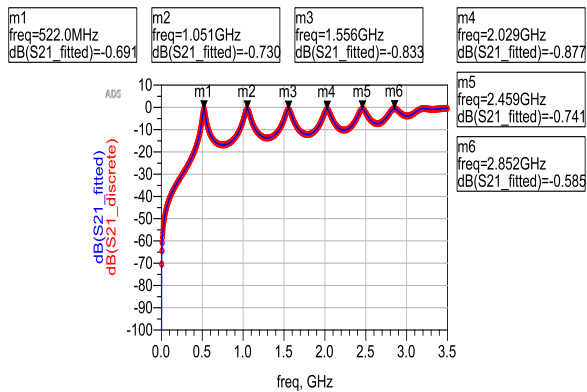

Fig.11.For 20% glucose concentration

4. For 30% glucose concentration:

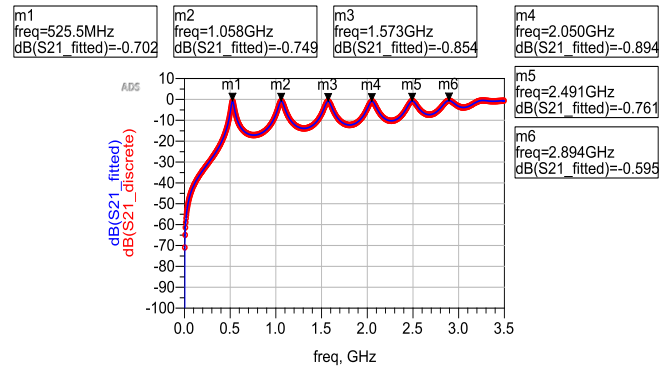

Fig.12.For 30% glucose concentration

5. For 40% glucose concentration:

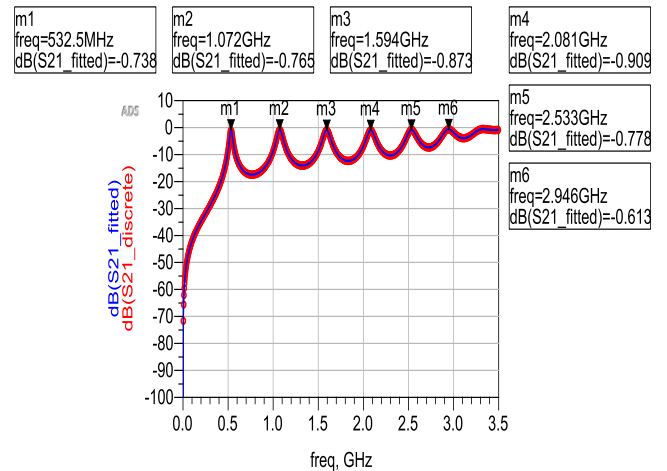

Fig.13. For 40% glucose concentration

6. For 50% glucose concentration:

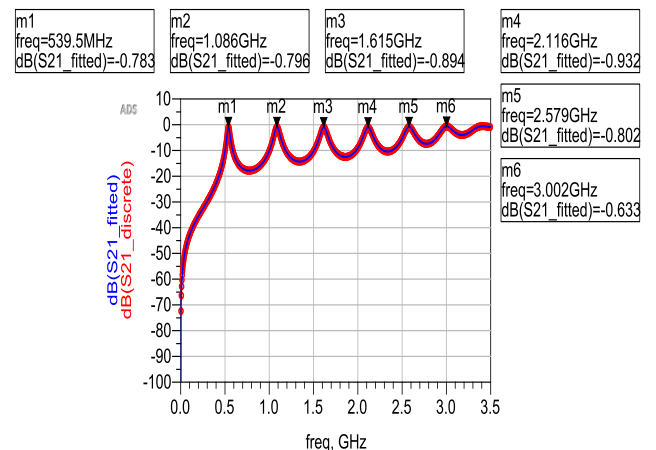

Fig.14. For 50% glucose concentration

VII. PROPOSED WORK

The ring resonator will be folded further to achieve low profile and more resolution in frequency shift even for slight change in glucose percentage.

- Effective existing layout:

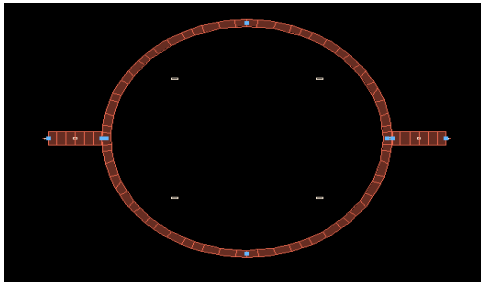

Fig.15. Existing Layout of Ring Resonator

- Proposed layout modification:

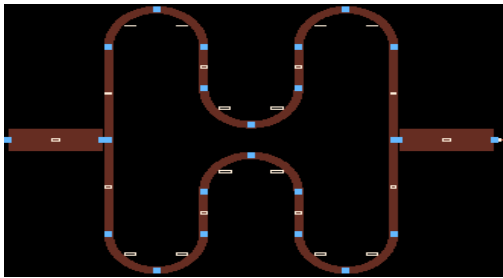

Fig.16. Proposed schematic

VIII.CONCLUSION

Simulation results of Microstrip ring resonator, single spiral ring resonator and double spiral resonator shows that, ring resonator gives measurable shift as per concentration of aqueous glucose changes than the other resonators. The proposed work is to make change in shape of ring resonator such that it gives maximum measurable shift as per small changes in concentration of aqueous glucose without making direct contact to blood with small antenna size.

ACKNOWLEDGEMENT

I would like to express my gratitude to my supervisor Principal Dr.S.D.Sawarkar. I thank Dr. D.J.Pete for his guidance and discussions on this paper.

REFERENCES

- [1]. Muley and R. B. Ghongade, "Design and Simulate an Antenna for Aqueous Glucose Measurement", Annual IEEE India Conference (INDICON), India, pp.1-6, 2014.
- [2]. S. Seewattanapon, T. Wattakeekamthorn, T. Somwong, P. Akkaraekthalin, "A Microstrip Folded Resonator Sensor for Measurement of Dielectric Constant", 2008 5th International Conference on Electrical Engineering/Electronics, Computer, Telecommunications and Information Technology, Thailand, 2008, pp. 245-248.
- [3]. X. Xiao and Q. Li, "A Noninvasive Measurement of Blood Glucose Concentration by UWB Microwave Spectrum", IEEE Antennas and Wireless Propagation Letters, Vol.16, No.10 , pp.1040-1043, 2017.
- [4]. Mehak, Shashi B. Rana and Yogesh Bhomia, "Design and Analysis of Modified Sierpinski Gasket Fractal Antenna", International Journal of Computer Sciences and Engineering, Vol.4, Issue.6, pp.150-155, 2016.
- [5]. Maximilian Hofmann, Thomas Fersch, Robert Weigel, Georg Fischer, Dietmar Kissinger, "A Novel Approach to Non-Invasive Blood Glucose Measurement based on RF Transmission", IEEE International Symposium on Medical Measurements and Applications, Italy, pp. 39-42, 2011.
- [6]. Heungjae Choi, Steve Luzio, Adrian Porch, "Dielectric Properties of Aqueous Glucose Solutions Using Microwave Cavity and Coaxial Probe", 2016 IEEE 2nd Australian Microwave Symposium (AMS), Australia, pp.7-8, 2016.